



Pressure level transmitter

# Huba Control

## Level sensing relative and absolute pressure transmitter Type 712

The level sensing pressure transmitter Type 712 is manufactured using a relative or absolute pressure measuring cell with an adjusted and amplified sensor signal and is available with various cable lengths from 2 to 30 meters. The Type 712 offers Ex protection as well as versions with integrated temperature measurement.

In addition to voltage and current outputs the Type 712 is available with ratiometric outputs.



**Pressure range**  
**0 ... 0.3 - 3 bar**

- + suitable for drinking water
- + intrinsically safe execution with voltage- and current output
- + suitable for fitting in 1-inch pipe
- + with integrated temperature measurement

## Technical overview

### Pressure range

Relative	0.0 ... 0.3 – 2.5 bar
Absolute	0.8 ... 1.4 – 3.0 bar

### Operating conditions

Medium	Fuel oil, ultra-light <sup>1)</sup>	SN 181 160-2
	Fuel oil, heavy <sup>1)</sup>	SN 181 160-2
	Diesel oil <sup>1)</sup>	
	Benzine <sup>1)</sup>	
	Drinking water (with EPDM O-ring)	
Temperature	Medium and ambient <sup>2)</sup>	-20 ... +80 °C
	Storage	-40 ... +80 °C
Overload		3x fs; max. 3 bar at 0.3 bar version

### Materials in contact with medium

Case	Stainless steel 1.4404 / AISI 316L
Sensor	Ceramic Al <sub>2</sub> O <sub>3</sub>
Cable	PE-HD
Protection cover	PPE, PA6
Sealing material	FPM, EPDM (for drinking water)

### Electrical overview

	Output	Power supply	Load	Current consumption
2 wire	4 ... 20 mA	10 ... 30 VDC	< $\frac{\text{Power supply} - 10V}{R_{load}}$ [Ohm]	< 20 mA
3 wire	0 ... 10 V	12 ... 30 VDC	> 10 kOhm / < 100 nF	< 5 mA
4 wire (with temperature)	ratim. 10 ... 90%	5 VDC ±10%	> 5 kOhm / < 100 nF	< 3 mA
4 wire (with temperature)	ratim. 10 ... 90%	5 VDC ±10%	> 5 kOhm / < 100 nF	< 3 mA
Polarity reversal protection	Short circuit proof and protected against polarity reversal.			
Overvoltage protection			4 ... 20 mA / 0 ... 10 V	36 VDC
			ratim. 10 ... 90 %	6 VDC
Electric strength towards case				500 VDC
Temperature output				> 1 MOhm

### Dynamic response

Response time	< 2 ms
---------------	--------

### Runtime

Time starts at the moment of application of minimal supply voltage	< 10 ms
--	---------

### Electrical connection

Cable PE-HD length 2, 5, 10, 15, 20, 30 m	<b>Protection standard</b> IP 68
---	-------------------------------------

### Test / Admissions

Electromagnetic compatibility	CE-conform acc. to EN 61326-2-3
UL	ANSI/UL 61010-1 acc. to E325110
Drinking water approval	ACS WRAS
Drinking water verification certificate for plastic parts	UBA guidance or KTW W270

### Ex-protection

IECEX SEV 12.0006	Ex II 1 G Ex ia IIC T4 Ga
SEV 12 ATEX 0138	Ex ia IIC T4 GaX
UL Ex E521059	Class I, Division 1, Groups A, B, C, D T4 Class I, Zone 0, AEx ia IIC T4 GA

### Weight

Without cable	~ 200 g
---------------	---------

### Packaging

Single packaging	
------------------	--

## Accuracy

Standard

Parameter	Unit	
Max. deviation <sup>3)</sup> at 25 °C	% fs	± 0.8
Resolution <sup>4)</sup>	% fs	0.1
Long term stability acc. IEC EN 60770-1	max. % fs	± 0.25
Thermal characteristic <sup>5), 6)</sup>	% fs/10K	± 0.2

Higher accuracy (only with ratiometric execution and pressure range ≥ 1 bar)

Parameter	Unit	
Max. deviation at compensated temperature range at -10 ... +60 °C <sup>3)</sup>	% fs	± 0.5
Resolution <sup>4)</sup>	% fs	0.1
Long term stability acc. IEC EN 60770-1	max. % fs	± 0.25

<sup>1)</sup> Ex-protection to attention!  
<sup>4)</sup> pressure range 0.3 bar < 0.2 % fs

<sup>2)</sup> non-congealing media  
<sup>5)</sup> at -20 ... +80 °C

<sup>3)</sup> incl. zero point, full scale, linearity, hysteresis and repeatability  
<sup>6)</sup> 0.3 bar-type with output 4 ... 20 mA = ±0.5% fs/10K

				1	2	3	4	5	6	7	8	9	10	
<b>Order code selection table</b>				712.	X	X	X	X	X	X	X	X	X	
<b>Pressure mode</b>	Absolute			8										
	Relative			9										
	Absolute with higher accuracy			C				1,2						
	Relative with higher accuracy			D				1,2						
<b>Pressure range <sup>1)</sup></b>	0.0 ... 0.3 bar	relative pressure	Pmax. 3.0 bar	9	1	3								
	0.0 ... 1.0 bar	relative pressure	3.0 bar	9,D	1	1								
	0.0 ... 1.6 bar	relative pressure	4.8 bar	9,D	1	2								
	0.0 ... 2.5 bar	relative pressure	7.5 bar	9,D	1	4								
				Max measurable level (for water depending on the locations weather)										
	0.8 ... 1.4 bar	absolute pressure	4.5 bar	3.5 ... 6.7 mWs	8	1	1							
	0.8 ... 2.0 bar	absolute pressure	6.0 bar	9.6 ... 12.8 mWs	8,C	1	2							
0.8 ... 3.0 bar	absolute pressure	9.0 bar	20.0 ... 23.0 mWs	8,C	1	4								
▲ Full scale signal at these pressures ① P <sub>BARO</sub> = 1060 mbar (high pressure on sea level) ② P <sub>BARO</sub> = 740 mbar (low pressure at 2000 meters above sea level)														
<b>Sealing material</b>	FPM Fluoro-elastomer							0						
	EPDM Ethylene propylene (for drinking water)							1						
<b>Output / power supply</b>	4 ... 20 mA 10 ... 30 VDC							0						
	ratiom. 10 ... 90% 5 VDC ±10%							1						
	ratiom. 10 ... 90% 5 VDC ±10% (with temperature)							2						
	0 ... 10 V 12 ... 30 VDC							3				0		
<b>Electrical connection <sup>2)</sup></b>	2 m							0						
	5 m							1						
	10 m							2						
	15 m							3						
	20 m							4						
	30 m							5						
<b>Protection cover</b>	without protection cover									2	0			
	with protection cover									2	1			
<b>Ex-protection</b>	without ex-protection (protection cover PPE)											0		
	with ex-protection (protection cover PA6 without drinking water approval)												4	
<b>Pressure range variation (optional)</b>	Indicate W and state range on order (e.g.: W 0 ... +2 bar/OUT 0 ... 10 V)												W	

## Electrical connections

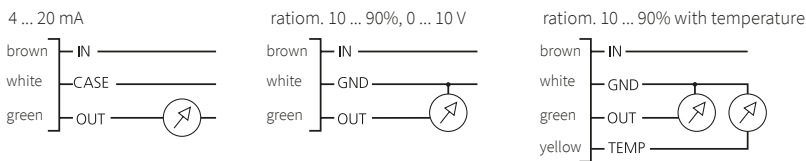

**Device design with explosion protection: 4 ... 20 mA**  
 The grounding connection is conductively connected to the level transmitter housing. The ground conductor of level transmitter must be connected to the equipotential bonding system of the plant.

**Device design with explosion protection: ratiometric 10 ... 90%**  
 The electronic GND is connected with a 1MΩ resistor to the level transmitter housing. The GND conductor of level transmitter must be connected to the equipotential bonding system of the plant.

**Ex**

## Dimensions in mm

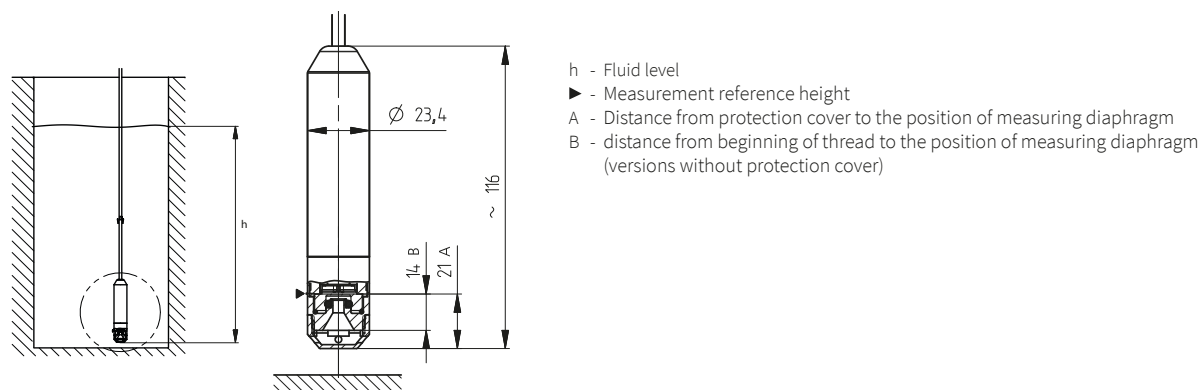

<sup>1)</sup> Other pressure range on request      <sup>2)</sup> Other cable length on request

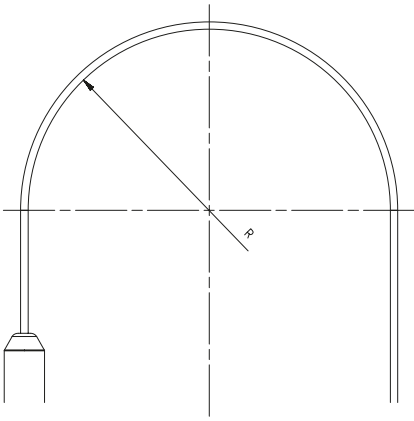

Bend radius			
Cable material	fixed	flexible	Temperature range for fixed installation
PE	≥ 50 mm	≥ 100 mm	-40°C ... +80°C

**Important:** The cable must NOT:

1. Be bent smaller than the bending radius.  
The individual wires on the inside are compressed, the individual wires on the outside are stretched and break off.
2. Be guided around sharp-edged corners.  
In addition to the risk of individual wires being torn off, there is also the risk of the isolation being worn through by e.g. vibration. Use cable bushings, corrugated pipes, edge protection, etc. to protect the cable when drilling holes.

### Accessories *(supplied loose)*

### Order number

Cable hanger	118026
Connection box (not suitable for output/feeding ratiometric with temp. (4-L))	118027
Test adapter	118028
Protection cover (pack of 10)	118067
Humidity protection element (pack of 10)	118068
Additional weight	118093
Calibration certificate	104551

#### Connection box

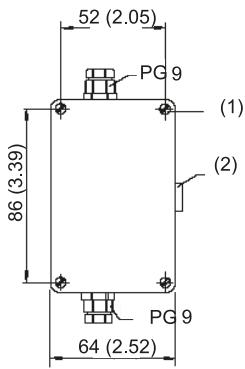

- (1) Mounting hole  
(2) Vent valve

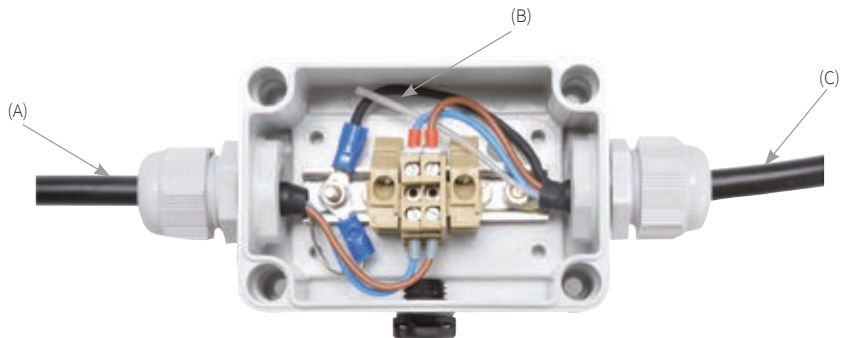
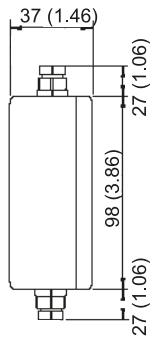

- (A) Measuring value process  
(B) Vent pipe  
(C) to the transmitter

#### Additional weight ~200 g

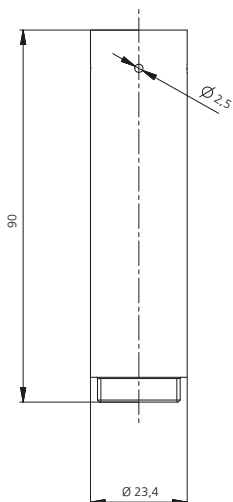

#### Test adapter

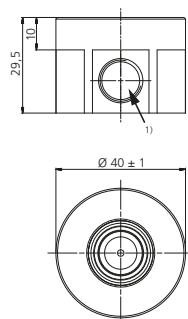

- 1) Inside thread Iso 228/1-G 1/4 A

#### Cable hanger

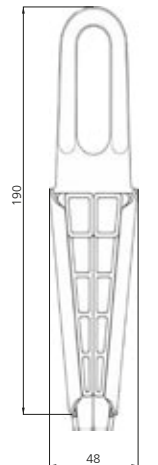

hot-dip galvanized steel –  
PA6 glass fibre reinforced

Cable Ø 4.5 ... 6.5

## Calculation of level

General level with relative pressure sensor:

$$h = \frac{\Delta p}{\rho \cdot g}$$

General level with absolute pressure sensor:

$$h = \frac{P_{TS} - P_{Baro}}{\rho \cdot g}$$

which

$$P_{TS} = \frac{U_{TS} - U_{TS\_NP}}{U_{TS\_EW} - U_{TS\_NP}} \cdot (P_{TS\_EW} - P_{TS\_NP}) + P_{TS\_NP}$$

and

$$P_{Baro} = \frac{U_{Baro} - U_{Baro\_NP}}{U_{Baro\_EW} - U_{Baro\_NP}} \cdot (P_{Baro\_EW} - P_{Baro\_NP}) + P_{Baro\_NP}$$

Using a second level sensor as barometric air pressure sensor

For level sensor with current output use nominal signal values for  $I_{TS}$  ... instead of variables  $U_{TS}$  ... (resp.  $I_{Baro}$  ... instead of  $U_{Baro}$  ...)

Simplification of formula for level sensor with ratiometric output:

$$P_{TS} = \frac{U_{TS} - 0.1 \cdot U_{IN}}{0.8 \cdot U_{IN}} \cdot (P_{TS\_EW} - P_{TS\_NP}) + P_{TS\_NP}$$

$$P_{Baro} = \frac{U_{Baro} - 0.1 \cdot U_{IN}}{0.8 \cdot U_{IN}} \cdot (P_{Baro\_EW} - P_{Baro\_NP}) + P_{Baro\_NP}$$

Using a second level sensor as barometric air pressure sensor

Legend:

h	level [m]	$\rho$	density of media [kg/m <sup>3</sup> ]
$\Delta p$	measured relative pressure [Pa]	g	acceleration of fall 9.80665 [m/s <sup>2</sup> ]
$P_{TS}$	measured pressure of level sensor [Pa]	$U_{TS}$	signal on level sensor output [V or mA]
$P_{Baro}$	measured pressure of barometer [Pa]	$U_{Baro}$	Signal on barometer output [V or mA]
$P_{TS\_NP}$	minimal nominal pressure of level sensor [Pa]	$U_{TS\_NP}$	minimal nominal signal of level sensor [V or mA]
$P_{TS\_EW}$	maximum nominal pressure of level sensor [Pa]	$U_{TS\_EW}$	maximum nominal signal of level sensor [V or mA]
$P_{Baro\_NP}$	minimal nominal pressure of barometer [Pa]	$U_{Baro\_NP}$	minimal nominal signal of barometer [V or mA]
$P_{Baro\_EW}$	maximum nominal pressure of barometer [Pa]	$U_{Baro\_EW}$	maximum nominal signal of barometer [V or mA]

## Specification temperature output

$$T_{TEMP} = T_0 + 1 \left/ \left( a + b \cdot \ln \left( R \cdot \left[ \frac{U_{IN}}{OUT\ T} - 1 \right] \right) + c \cdot \ln \left( R \cdot \left[ \frac{U_{IN}}{OUT\ T} - 1 \right] \right)^3 \right) \right.$$

$T_{TEMP}$  Temperature NTC [°C]  
 $T_0$  -273.15 [°C]

OUT T Voltage NTC [V]  
 R 20'000 [Ω]  
 $U_{IN}$  4.5 ... 5.5 [V]

a = 0.001204001  
 b = 0.000208775  
 c = 0.000000294

$T_{TEMP} = f(OUT\ T)$

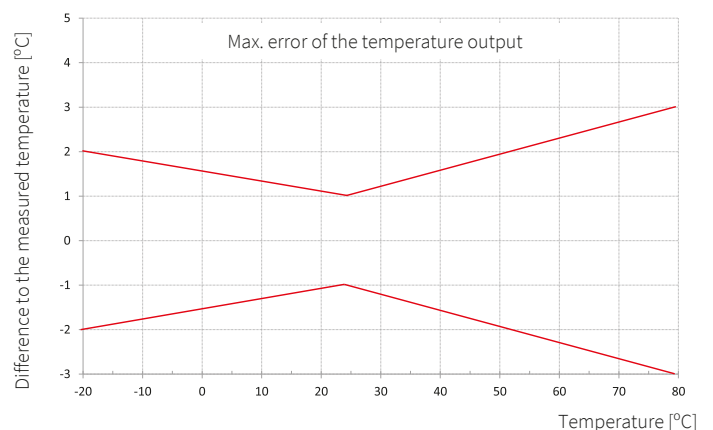
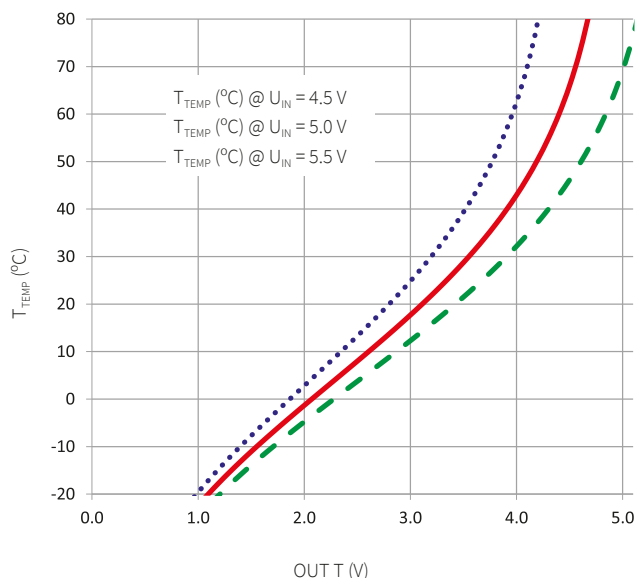

**Huba Control AG**

Industriestrasse 17  
5436 Würenlos, Switzerland  
Tel. +41 56 436 82 00  
info.ch@hubacontrol.com



Consultancy in your area  
[hubacontrol.com/en/worldwide](https://hubacontrol.com/en/worldwide)

